

Disegno tecnico industriale

Fabrizio Stefani

Esercitazione 1

Introduzione al disegno tecnico

Esercizi grafici di base

Linee e quote con gli strumenti di Microstation

TIPI DI LINEA

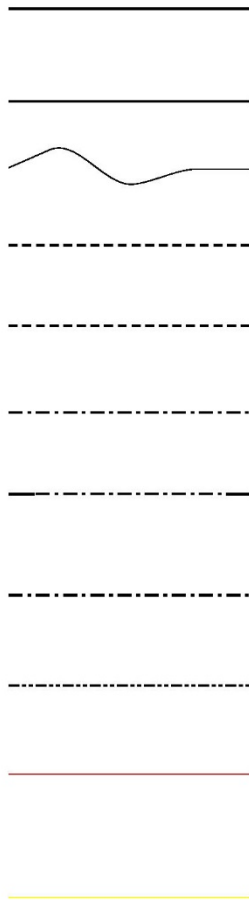

ACCUDRAW

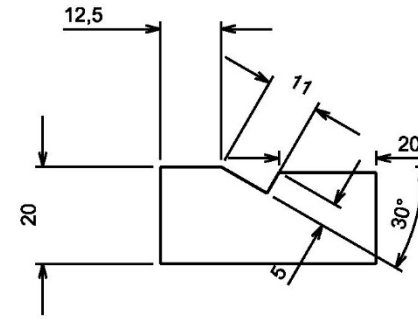

ACCUSNAP

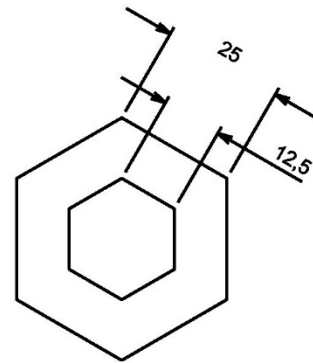
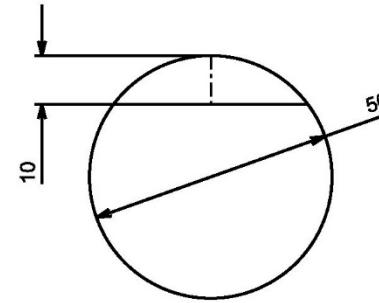

cattura centro

punto vicino

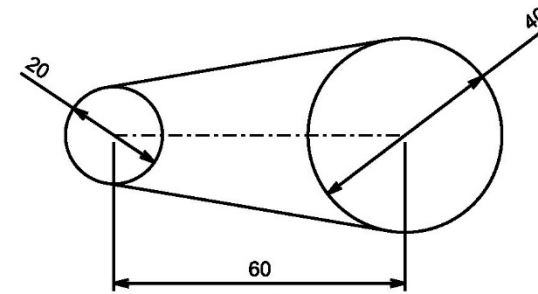

cattura tangenti

Tagli ed estensioni con gli strumenti di Microstation

Intellitrim: estendi

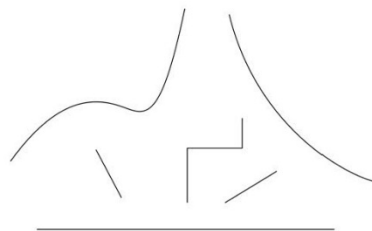

Intellitrim: delimita

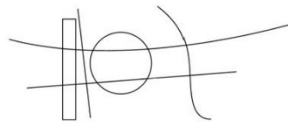

Cancellazione tramite interrompi elemento con snap all'intersezione

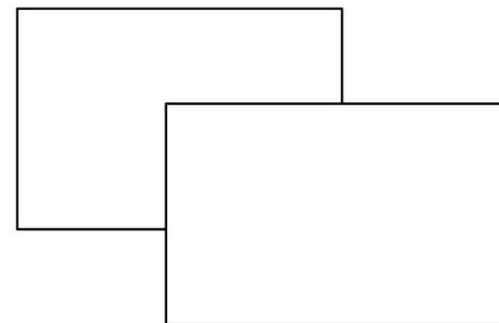
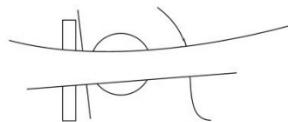
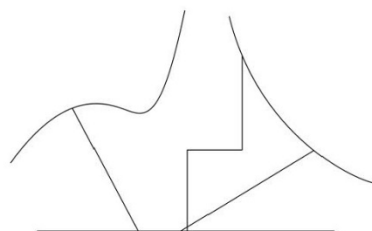
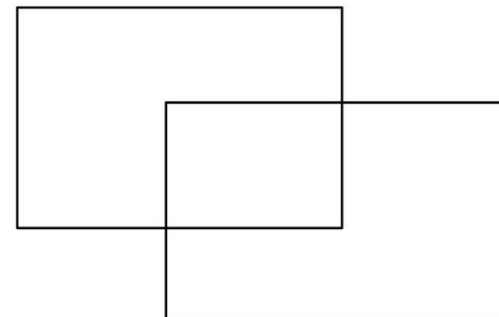

UNIVERSITÀ DI GENOVA C.D.L. ING. MECCANICA (SP)	
DISEGNO TECNICO INDUSTRIALE 1	
CODICE	DIS. N.RO
MANCOLA	SCALA

Simmetrie e copie

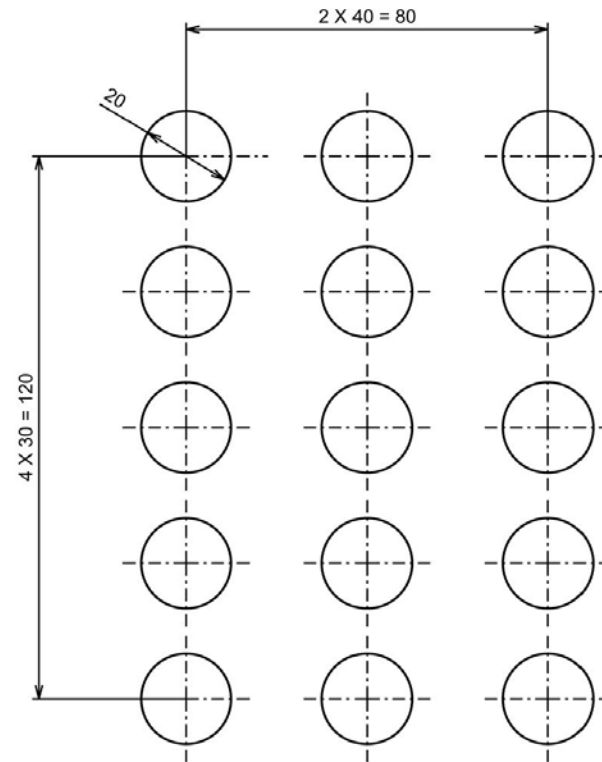
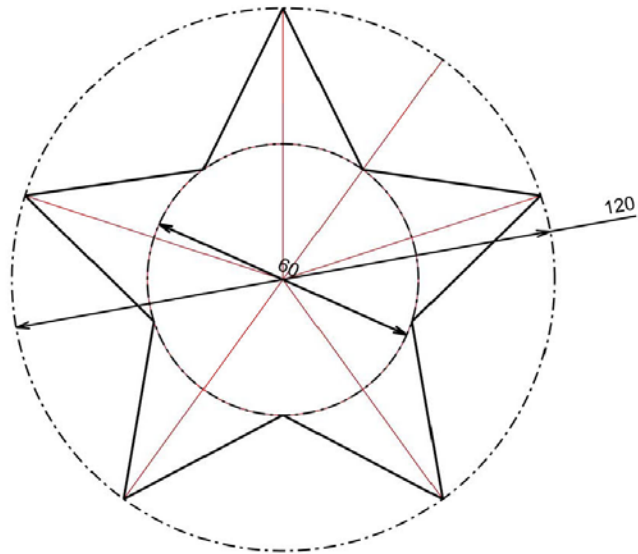

UNIVERSITÀ DI GENOVA C.O.L. ING. MECCANICA (SP)	
DISEGNO TECNICO INDUSTRIALE 1	
CODICE	DIS. N.RO
MATRICOLO	SCALA